

 **breviglieri**

POWER HARROWS

ERPICI ROTANTI

HERSES ROTATIVES

KREISELEGGEN

GRADAS ROTATIVAS



 **breviglieri**

Uomini, idee, macchine.



The range

Available for tractors from 30 up to 260 HP

- I Disponibili per trattori da 30 a 260 cv
- F Disponibles pour tracteurs de 30 à 260 cv
- D Verfügbar für Traktoren von 30 bis 260 PS
- E Disponibles para tractores de 30 a 260 cv

I La gamma F La gamme D Die Auswahl E La gama

Mekfarmer 80



30 - 80 HP

cm. 110 - 130 - 150 - 170 - 190

Mekfarmer 100



60 - 100 HP

cm. 200 - 230 - 250 - 300

Mekfarmer 120



90 - 120 HP
cm. 250 - 300 - 350

Mekfarmer 150



90 - 150 HP
cm. 250 - 300 - 350

Mekfarmer 170



100 - 170 HP
cm. 300 - 350 - 400

Mekfarmer 220



140 - 220 HP
cm. 300 - 350 - 400 - 450

Mekfarmer K180



100 - 180 HP
cm. 300 - 350 - 400

Mekfarmer K230



140 - 230 HP
cm. 300 - 350 - 400 - 450

Mekfarmer K270



150 - 270 HP
cm. 300 - 350 - 400 - 450



BALL BEARINGS

- 1 Cuscinetti a sfera F Roulements à billes
- 2 Kugellager E Cojinetes a esferas

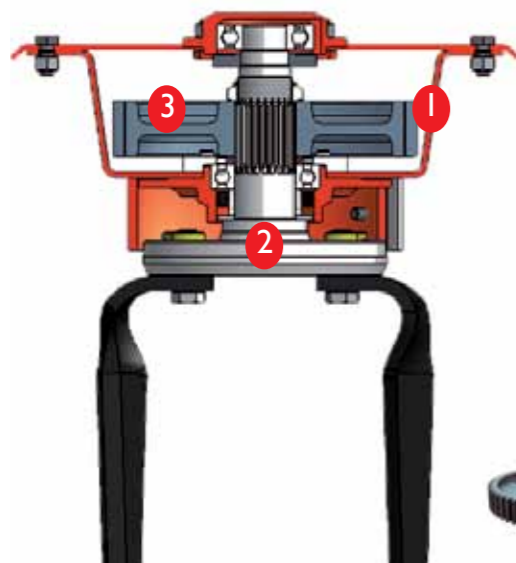

TAPERED ROLLER BEARINGS

- 1 Cuscinetti conici F Roulements coniques
- 2 Konische Lagerungen E Cojinetes cónicos

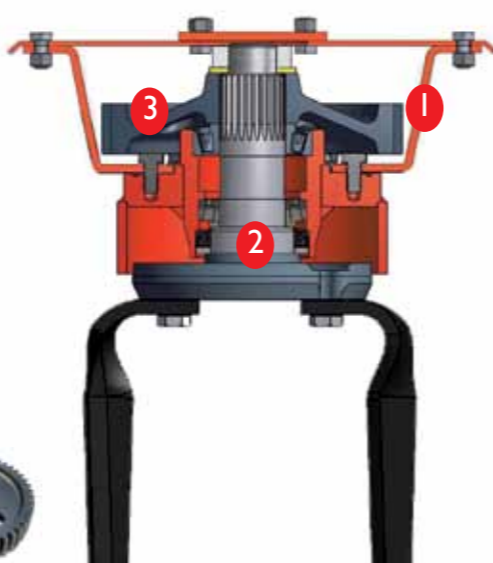

SPECIAL MOUNTING OF BLADES

- 1 Fasatura coltelli F Décalage des couteaux D Zinken E Montaje special cuchillas

This system to assembly the blades allows:

- 1 Questo particolare sistema di montaggio dei coltelli consente:
- 2 Ce système spécial de montage des lames permet de:
- 3 Dieses spezielle Zinkenmontagesystem erlaubt:
- 4 Este sistema de montaje de las cuchillas permite de:

- 1 To eliminate the vibrations
- 2 Eliminare le vibrazioni
- 3 Éliminer les vibrations
- 4 Die Vibrationen zu entfernen
- 5 Eliminar las vibraciones

- 2 To reduce the absorption of power and a saving fuel consumption

- 1 Ridurre l'assorbimento di potenza e consumi di carburante
- 2 Réduire l'absorption de puissance et consommations de carburant
- 3 Die Absorption der Kraft und des Treibstoffverbrauchs zu verringern
- 4 Reducir la absorción de potencia y consumos de carburante

- 3 Fine clods for a perfect seeded

- 1 Zolle fini per una perfetta semina
- 2 Des mottes fines pour une parfaite semée
- 3 Dünne Scholle für eine perfekte Aussaat
- 4 Terrones finos para una perfecta siembra

SIDE SHIELDS

- 1 Deflettori laterali F Déflecteurs latéraux D Seitenschilder E Deflectores laterales

standard: MekFarmer 80



standard: MekFarmer 100



standard: MekFarmer 120
MekFarmer 150
MekFarmer 170
MekFarmer 220
MekFarmer K 180
MekFarmer K 230
MekFarmer K 270



standard: MekFarmer 120
MekFarmer 150
MekFarmer 170
MekFarmer 220
MekFarmer K 180
MekFarmer K 230
MekFarmer K 270



MOD.	1	2	3	MOD.	1	2	3	MOD.	1	2	3
Mekfarmer 80	mm 3	mm 45	40	Mekfarmer 150	mm 5	mm 50	48	Mekfarmer K180	mm 7+7	mm 55	40
Mekfarmer 100	mm 5	mm 45	40	Mekfarmer 170	mm 7	mm 50	48	Mekfarmer K230	mm 7+7	mm 55	40
Mekfarmer 120	mm 5	mm 50	48	Mekfarmer 220	mm 7	mm 50	48	Mekfarmer K270	mm 7+7	mm 55	40

- 1 Flat-pan thickness steel
- 2 Spessore lamiera vasca
- 3 Epaisseur tôle
- 4 Dick des Bleches der Wanne
- 5 Espesor plancha
- 6 Side blade holder shaft diam.
- 7 Diametro albero portadente laterale
- 8 Diamètre arbre porte dent latéral
- 9 Seitliche Zinkenträger durchmesser
- 10 Diametro eje porta-diente central
- 11 Nr. tines gear transmission
- 12 N° denti ingranaggio di trasmissione
- 13 Nombre dents engrange
- 14 Nr. der Zahnen der Antriebszahnäder
- 15 Nr. dientes engranje de transmisión

SUPERFAST

Without tools! Without effort!

- 1 Senza attrezzi! Senza fatica!
- 2 Sans outils! Sans fatigue!
- 3 Ohne Werkzeug! Ohne Mühe!
- 4 Sin las herramientas! Sin esfuerzo!

The BREVIGLIERI system in order to replace blades in a moment

- 1 Il sistema Breviglieri per sostituire gli utensili in un attimo
- 2 Le système BREVIGLIERI pour changer les outils dans un seul instant
- 3 Das BREVIGLIERI System für di Werkzeuge sofort zu ersetzen
- 4 El sistema BREVIGLIERI para substituir las cuchillas en un momento

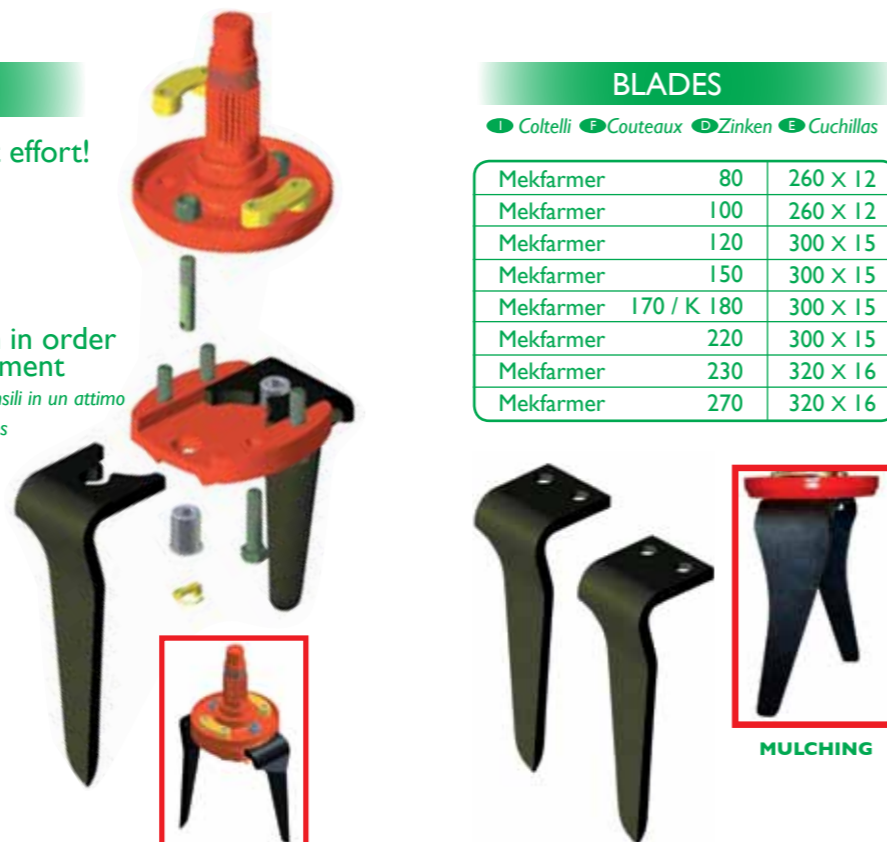

MULCHING

AVAILABLE ON

- 1 Disponibile
 - 2 Disponible
 - 3 Verfügbar
 - 4 Disponible
- Mekfarmer 150 - 170 - 220 - K180 - K230 - K270



REAR ROLLERS

1 Rulli posteriori 2 Rouleaux arrière 3 Hintere Walzen 4 Rodillos posteriores



Spiked roller (Ø 477-525) (Ø 102-164)
 1 Rullo dentato
 2 Rouleau à dents
 3 Zinkenwalze
 4 Rodillo a dientes



Cage roller (Ø 370-405-450-500)
 1 Rullo gabbia
 2 Rouleau cage
 3 Stabwalze
 4 Rodillo jola



Packer roller (Ø 406-464-500-550)
 1 Rullo packer
 2 Rouleau packer
 3 Zahnpackerwalze
 4 Rodillo packer



Spiked roller maxi (Ø 525) (Ø 273)
 1 Rullo dentato maxi
 2 Rouleau à dents maxi
 3 Zinkenwalze maxi
 4 Rodillo dentado maxi



Crumbling roller (Ø 412-500)
 1 Rullo sminuzzatore
 2 Rouleau emoteur
 3 Krummenpackerwalze
 4 Rodillo desmenuzador



Spiral roller (Ø 460)
 1 Rullo spirale
 2 Rouleau spire
 3 Spiralwalze
 4 Rodillo espiral

ROLLERS ADJUSTEMENT

1 Regolazione rulli 2 Réglage rouleaux 3 Walzenverstellung 4 Ajuste rodillos



STANDARD
 With pins
 1 A perni
 2 Par tourillons
 3 Mit Spindel
 4 A pernos



OPTION
 Mechanical jacks (2)
 1 Martinetti meccanici (2)
 2 Vérins mécaniques (2)
 3 Mit Bolzen (2)
 4 Con tornillos (2)



OPTION
 Hydraulic jacks (2)
 1 Martinetti idraulico (2)
 2 Vérins hydraulique (2)
 3 Hydraulische Zylinder (2)
 4 Cilindro hidráulico (2)

PTO SHAFT

1 Cardano 2 Cardan 3 Gelenkwille 4 Cardan



With shear bolt
 1 Con limitatore a bulloni
 2 Avec limiteurs à boulons
 3 Mit Scherstift
 4 Con limitador a bulón

STANDARD
 Mekfarmer 80-100



With slip clutch
 1 Con frizione a dischi
 2 Avec sécurité à disques
 3 Rutschkupplung
 4 Con embragues de discos

STANDARD
 Mekfarmer 120-150-170-220
 Mekfarmer K180-K230-K270

OPTION
 Mekfarmer 80-100



With cam clutch
 1 Con sicurezza automatica
 2 Avec sécurité à came
 3 Mit Nockenschaltkupplung
 4 Con embrague de seguridad

OPTION
 Mekfarmer 120-150-170-220
 Mekfarmer K180-K230-K270

HYDRAULIC SEEDER LINKAGE

1 Attacco idraulico seminatrici
 2 Attelage hydraulique semair
 3 Hydraulische Drillmaschinenanbauteile
 4 Enganche hidráulico sembradora



MAX LOAD KG 2000

BACK REFLEX PANELS



1 Pannelli retroriflettenti
 2 Panneaux de signalisation
 3 Erkennungstafel
 4 Paneles retroreflejantes

OPTION
 Mekfarmer 120-150
 170-220
 Mekfarmer K180
 K230-K270

STONE PROTECTION

1 Protezione sassi
 2 Protéctions cailloux
 3 Wickel Steinschutz
 4 Protección piedras



STANDARD
 Mekfarmer 150-170-220
 Mekfarmer K180-K230-K270

OPTION
 Mekfarmer 80-100-120

REAR PTO

1 PDF Posteriore
 2 PDF arrière
 3 Hinter Durchtrieb
 4 Toma de fuerza posterior



STANDARD
 Mekfarmer 150-170-220
 Mekfarmer K180-K230-K270

OPTION
 Mekfarmer 100-120

RIGID TRACK ERADICATOR

1 Ancora rompitraccia
 2 Effaceur de trace
 3 Spurlockerer
 4 Eliminador de rostro



OPTION
 Mekfarmer 80-100-120-150-170-220
 Mekfarmer K180-K230-K270

REAR LEVELLING BAR

1 Barra livellatrice posteriore
 2 Barre niveleuse arrière
 3 Hintere Planierschiene
 4 Barra niveladora trasera











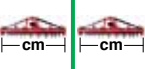

STANDARD
 Mekfarmer 100-120-150-170-220
 Mekfarmer K180-K230-K270

OPTION
 Mekfarmer 80

	540 RPM		1000 RPM		Cod.	
	1	2	3	4		
Mekfarmer 80	-	-	324	-	8201423	standard
	19	21	293	-		option
	21	19	358	-	8201427	option
	18	22	265	-		
Mekfarmer 100 - 120	22	18	396	-	8201424	standard
	17	16	311	-		
	16	17	275	-	8201428	option
	18	15	351	-		
	15	18	244	-	8201429	option
12	21	-	309			
Mekfarmer 150	13	20	-	352	8201430	
	32	24	348	-	8066254	standard
	24	32	-	362		
	30	26	301	-	8066256	option
	33	23	374	-		
	25	31	-	389	8066258	
22	34	-	312	8066259		
Mekfarmer 170 / K 180	26	35	-	359	8066239	standard
	35	26	350	-		
	21	40	-	253	8066232	
	23	38	-	292		
	38	23	430	-	8066233	
	24	37	-	313		
	37	24	402	-	8066234	option
	25	36	-	335		
	36	25	375	-	8066235	
	27	34	207	383		
	34	27	328	-	8066236	option
	28	33	221	410		
33	28	307	-	8066237		
29	32	236	438			
32	29	288	-	8066238		
Mekfarmer 220 / K 230	18	19	-	332	8201426	standard
	19	18	-	371		
	16	21	-	267	8201433	option
	21	16	-	461		
	17	20	-	298	8201434	
	20	17	-	413		
Mekfarmer K 270	30	39	-	365	8066462	standard
	23	46	-	238	8066460	
	27	43	-	298	8066461	option
	33	36	-	435	8066463	

Technical data

DATI TECNICI / DONNÉES TECHNIQUES / TECHNISCHE DATEN / DATOS TECNICOS

																					
			KG	KG			KG	KG	KG	KG	KG	KG	KG	KG	KG	KG	KG	KG	KG	KG	KG
Mod. MekFarmer	HP	rpm	cm	cm	n.	cm	Ø 477 1	Ø 525 2	Ø 525 3	Ø 405 x MekFarmer 80 Ø 370	Ø 450	Ø 500	Ø 460	Ø 412	Ø 500	Ø 406	Ø 464	Ø 500	Ø 550		
80-110	30-44	540		110	113	10	8-27	340			308								342		
80-130	40-50	540		130	133	12	8-27	375			338								396		
80-150	50-60	540		150	153	14	8-27	410			368								450		
80-170	60-80	540		170	173	16	8-27	445			398								504		
80-190	70-80	540		190	193	18	8-27	480			428								558		
100-200	60-70	540	1000	200	205	20	8-27	680			670	700		690	680			780	810		
100-230	65-80	540	1000	230	235	22	8-27	730			700	730		720	710			830	860		
100-250	70-90	540	1000	250	255	24	8-27	780			750	780		770	760			880	910		
100-300	80-100	540	1000	295	300	28	8-27	880			850	880		870	860			980	1010		
120-250	90-110	540	1000	250	255	20	10-30		935	980		910		910	880	950			1110	1180	1250
120-300	100-120	540	1000	295	300	24	10-30		1092	1137		1100	1200	1100	1070	1140			1195	1265	1335
120-350	100-120	540	1000	345	350	28	10-30		1192	1237		1200	1300	1200	1170	1240			1295	1365	1435
150-250	90-120	540	1000	243	252	20	10-30		1092	1138		1102		1102	1072	1142			1242	1312	1382
150-300	110-140	540	1000	288	300	24	10-30		1212	1258		1223	1323	1220	1183	1253			1362	1432	1502
150-350	120-150	540	1000	345	350	28	10-30		1282	1328		1293	1393	1290	1253	1323			1432	1502	1572
170 - 300 K180	100-130	540	1000	295	300	24	10-30		1190	1236		1220	1320	1223	1180	1250			1420	1472	1552
170 - 350 K180	110-150	540	1000	345	350	28	10-30		1330	1376		1360	1460	1360	1320	1390			1570	1640	
170 - 400 K180	120-170	540	1000	395	400	32	10-30		1470	1516		1500	1600	1500	1460	1530			1710	1780	
220-300	140-160		1000	295	300	24	10-30		1255	1301		1285	1385	1285	1245	1315			1450	1500	1570
220-350	150-170		1000	345	350	28	10-30		1400	1446		1430	1530	1430	1390	1460			1640	1730	
220-400	170-200		1000	395	400	32	10-30		1550	1596		1580	1680	1580	1540	1610			1790	1860	
220-450	180-220		1000	445	450	36	10-30		1700			1730	1830	1730	1690	1760			1940	2010	
K 230-300	140-160		1000	295	300	24	10-32		1255	1301		1285	1385	1285	1245	1315			1450	1500	1570
K 230-350	150-170		1000	345	350	28	10-32		1400	1446		1430	1530	1430	1390	1460			1640	1730	
K 230-400	170-200		1000	395	400	32	10-32		1550	1596		1580	1680	1580	1540	1610			1790	1860	
K 230-450	180-230		1000	445	450	36	10-32		1700			1730	1830	1730	1690	1760			1940	2010	
K 270-300	150-180		1000	295	300	24	10-32		1550	1595		1590	1690	1590	1550	1620			1730	1790	18060
K 270-350	150-200		1000	345	350	28	10-32		1710	1750		1700	1760	1760	1720	1810			1900	2010	
K 270-400	160-230		1000	395	400	32	10-32		1935	1926		1900	2000	1900	1860	1930			2110	2180	
K 270-450	180-270		1000	445	450	36	10-32					2060	2160	2060	2020	2090			2270	2340	

- 1** Tubo centrale Ø 102 (Ø 477) **GB** Central tube Ø 102 (Ø 477) **F** Tuyau centrale Ø 102 (Ø 477) **D** Zentral Rohr Ø 102 (Ø 477) **E** Tubo central Ø 102 (Ø 477)
2 Tubo centrale Ø 164 (Ø 525) Central tube Ø 164 (Ø 525) Tuyau centrale Ø 164 (Ø 525) Zentral Rohr Ø 164 (Ø 525) Tubo central Ø 164 (Ø 525)
3 Tubo centrale Ø 273 (Ø 525) Central tube Ø 273 (Ø 525) Tuyau centrale Ø 273 (Ø 525) Zentral Rohr Ø 273 (Ø 525) Tubo central Ø 273 (Ø 525)

